

### Scope of Performance LVS (R)

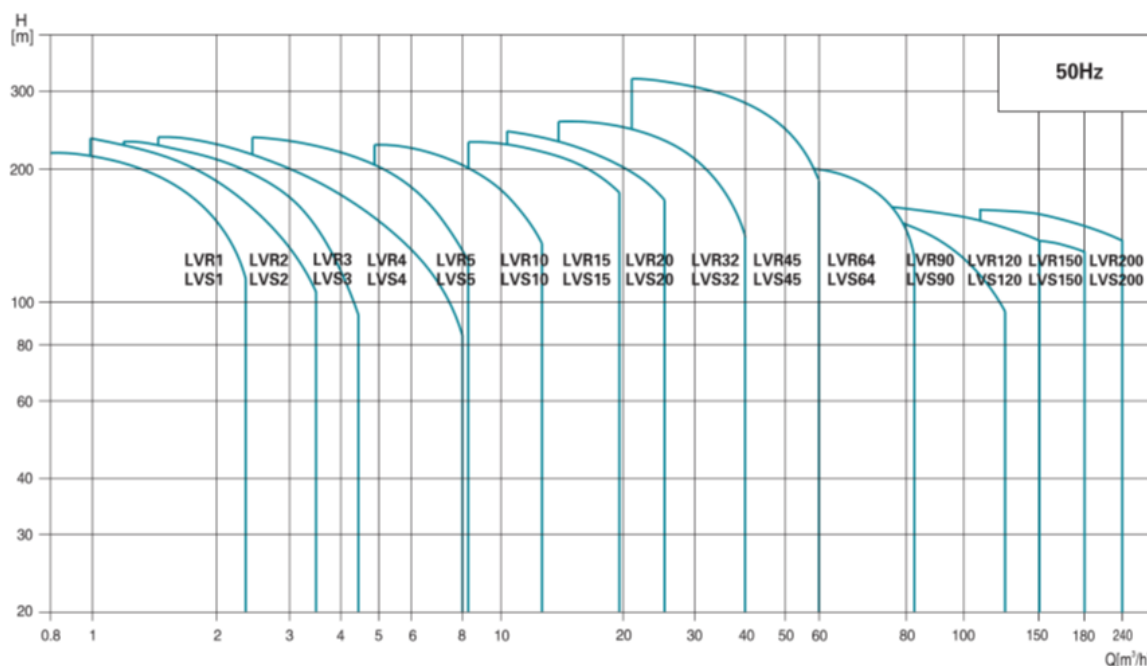

### Product Range

| MODEL                    | LVR(S)1  | LVR(S)2              | LVR(S)3              | LVR(S)4              | LVR(S)5              | LVR(S)10 | LVR(S)15 | LVR(S)20 | LVR(S)32 | LVR(S)45 | LVR(S)64 | LVR(S)90 | LVR(S)120 | LVR(S)150 | LVR(S)200 |
|--------------------------|--|----------------------|----------------------|----------------------|----------------------|----------|----------|----------|----------|----------|----------|----------|-----------|-----------|-----------|
| Rated flow [m³/h]        | 1  | 2                    | 3                    | 4                    | 5                    | 10       | 15       | 20       | 32       | 45       | 64       | 90       | 120       | 150       | 200       |
| Flow range [m³/h]        | 0.7-2.4  | 1.0-3.5              | 1.2-4.5              | 1.5-8                | 2.5-8.5              | 5-13     | 8-23     | 10.5-29  | 15-40    | 22-58    | 30-85    | 45-120   | 60-150    | 80-180    | 100-240   |
| Max. pressure [bar]      | 22   | 23                   | 24                   | 21                   | 24                   | 22       | 23       | 25       | 28       | 33       | 22       | 20       | 16        | 16        | 16        |
| Motor power [kW]         | 0.37-2.2   | 0.37-3               | 0.37-3               | 0.37-4               | 0.37-4               | 1.1-7.5  | 1.1-15   | 1.1-18.5 | 1.5-30   | 3-45     | 4-45     | 5.5-45   | 11-75     | 11-75     | 18.5-110  |
| Temperature Range [°C]   | -20°C--+120°C ( Note: Both the Max. permissible pressure and liquid temperature range refer to the pump capacity.) |                      |                      |                      |                      |          |          |          |          |          |          |          |           |           |           |
| Max. pump efficiency [%] | 45   | 46                   | 55                   | 59                   | 60                   | 65       | 70       | 72       | 78       | 79       | 80       | 81       | 74        | 73        | 79        |
| Pipe connection-LVR      |  |                      |                      |                      |                      |          |          |          |          |          |          |          |           |           |           |
| Oval flange              | G1   | G1                   | G1                   | G1 1/4               | G1 1/4               | -        | -        | -        | -        | -        | -        | -        | -         | -         | -         |
| DIN flange               | DN25   | DN25                 | DN25                 | DN32                 | DN32                 | DN40     | DN50     | DN50     | DN65     | DN80     | DN100    | DN100    | DN125     | DN125     | DN150     |
| Pipe connection-LVS      |  |                      |                      |                      |                      |          |          |          |          |          |          |          |           |           |           |
| Oval flange              | -  | -                    | -                    | -                    | -                    | -        | -        | -        | -        | -        | -        | -        | -         | -         | -         |
| DIN flange               | DN32   | DN32                 | DN32                 | DN32                 | DN32                 | DN40     | DN50     | DN50     | DN65     | DN80     | DN100    | DN100    | DN125     | DN125     | DN150     |
| Clamp connector          | φ42  | φ42                  | φ42                  | φ42                  | φ42                  | -        | -        | -        | -        | -        | -        | -        | -         | -         | -         |
| Threaded connector       | R <sub>2</sub> 1 1/4   | R <sub>2</sub> 1 1/4 | R <sub>2</sub> 1 1/4 | R <sub>2</sub> 1 1/4 | R <sub>2</sub> 1 1/4 | -        | -        | -        | -        | -        | -        | -        | -         | -         | -         |

## Ambient Temperature

An ambient temperature of over 40 ° C or an installation at an altitude above 1000 meters above sea level requires an oversized motor. Due to low air density and poor cooling, the output power P<sub>2</sub> decreases, as shown in the table below:

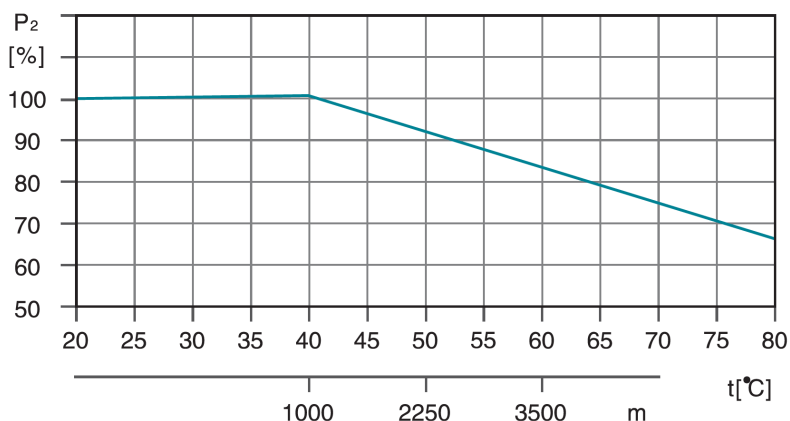

For example, when the pump is installed at an altitude of 3500 meters, P<sub>2</sub> will decrease by 88%. And when the ambient temperature is 70 ° C, P<sub>2</sub> will decrease by 78%.

## Maximum Operation pressure (bar)

The table below shows the maximum discharge pressures of the various LVS (R) pumps. The suction pressure of the pump + the set pressure must always be lower than the maximum operating pressure of the pump. If the maximum working pressure is exceeded, it can damage the motor bearings and reduce the service life of the mechanical seal.

| Model                     | LVR Max. Operation pressure [bar] |            | LVS Max. Operation pressure [bar] |
|---------------------------|-----------------------------------|------------|-----------------------------------|
|                           | Oval Flange                       | DIN Flange |                                   |
| LVR (S) 1                 | 16                                | 25         | 25                                |
| LVR (S) 2                 | 16                                | 25         | 25                                |
| LVR (S) 3                 | 16                                | 25         | 25                                |
| LVR (S) 4                 | 16                                | 25         | 25                                |
| LVR (S) 5                 | 16                                | 25         | 25                                |
| LVR (S) 10                |                                   | 25         | 25                                |
| LVR (S) 15                |                                   | 25         | 25                                |
| LVR (S) 20                |                                   | 25         | 25                                |
| LVR (S) 32-1-1 - 32-7     | 16                                |            | 16                                |
| LVR (S) 32-8-2 - 32-14    | 30                                |            | 30                                |
| LVR (S) 45-1-1 - 45-5     | 16                                |            | 16                                |
| LVR (S) 45-6-2 - 45-11    | 30                                |            | 30                                |
| LVR (S) 45-12-2 - 45-13-2 | 33                                |            | 33                                |
| LVR (S) 64-1-1 - 64-5     | 16                                |            | 16                                |
| LVR (S) 64-6-2 - 64-8-1   | 30                                |            | 30                                |
| LVR (S) 90-1-1 - 90-4     | 16                                |            | 16                                |
| LVR (S) 90-5-2 - 90-6     | 30                                |            | 30                                |
| LVR (S) 120-1 - 120-7     | 20                                |            | 20                                |
| LVR (S) 150-1-1 - 150-6   | 20                                |            | 20                                |
| LVR (S) 200-1-D - 200-4   | 20                                |            | 20                                |

## NPSH

### Minimum Inlet Pressure–Npsh

Calculation of the inlet pressure “H” is recommended in these situations:

- The liquid temperature is high.
- The flow is significantly higher than the rated flow.
- Water is drawn from depths.
- Water is drawn through long pipes.
- Inlet conditions are poor.

To avoid cavitation, make sure that there is a minimum pressure on the suction side of the pump. The maximum suction lift “H” in meters head can be calculated as follows:

$$H = P_b \times 10.2 - NPSH - H_f - H_v - H_s$$

$P_b$  = Barometric pressure in bar. (Barometric pressure can be set to 1 bar). In closed systems,  $P_b$  indicates the system pressure in bar.

NPSH = Net Positive Suction Head in meters head.  
(To be read from the NPSH curve at the highest flow the pump will be delivering.)

$H_f$  = Friction loss in suction pipe in meters head.  
(At the highest flow the pump will be delivering.)

$H_v$  = Vapor pressure in meters head. (To be read from the vapor pressure scale. “ $H_v$ ” depends on the liquid temperature “ $t_m$ ”)

$H_s$  = Safety margin=minimum 0.5 meters head.

If the “H” calculated is positive, the pump can operate at a suction lift of maximum “H” meters head.

If the “H” calculated is negative, an inlet pressure of minimum “H” meters head is required.

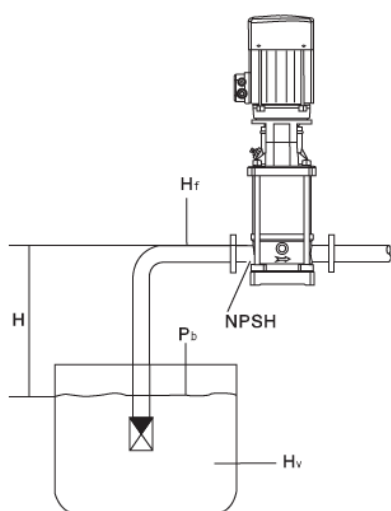

| $t_m$<br>[°C] | $H_v$<br>[m] |
|---------------|--------------|
| 190           | 126          |
| 180           | 100          |
| 170           | 79           |
| 160           | 62           |
| 150           | 45           |
| 140           | 40           |
| 140           | 35           |
| 130           | 30           |
| 130           | 25           |
| 120           | 20           |
| 110           | 15           |
| 100           | 12           |
| 100           | 10           |
| 90            | 8.0          |
| 90            | 6.0          |
| 80            | 5.0          |
| 80            | 4.0          |
| 70            | 3.0          |
| 60            | 2.0          |
| 50            | 1.5          |
| 50            | 1.0          |
| 40            | 0.8          |
| 40            | 0.6          |
| 30            | 0.4          |
| 30            | 0.3          |
| 20            | 0.2          |
| 10            | 0.1          |
| 0             | 0            |

**Note:** To avoid cavitation, never select a pump with a duty point too far to the right on the NPSH curve. Always check the NPSH value of the pump at the highest possible flow.

## LVR5 vertical multistage stainless steel in line pump



LVR

### Application

- Transfer of liquids with low viscosity, non-flammable and non-explosive, not containing solid particles or fibers. These liquids must not chemically attack the materials of the pump.
- Water supply for tall buildings, pumping stations, overpressure
- Washing stations, heating water circulation, air conditioning water circulation, water treatment systems
- Distillation systems, municipal swimming pools
- Irrigation: sprinkling, drip
- Industry
- Fire fighting systems

### Pompe

- Liquid temperature: from -20°C to +120°C
- Nominal flow: 5 m<sup>3</sup>/h
- maximum pressure: 24 bars
- pH between 4 and 10

### Moteur

- IE3 motor
- Protection class: IP55
- Maximum ambient temperature: +40°

### Identification codes

**LVR m 5 -10 -B /F(A, K, G)**

- DIN flange (oval, clamp fitting, threaded fitting)
- inox 316 (by default, inox 304)
- number of turbines
- Nominal flow (m<sup>3</sup>/h)
- Single-phase motor
- vertical multicellular pump in cast iron

## Technical data

| MODEL    | kW   | Q (m <sup>3</sup> /h) | 1   | 2   | 3   | 4   | 5   | 6   | 7   | 8   | 8.5 |
|----------|------|-----------------------|-----|-----|-----|-----|-----|-----|-----|-----|-----|
|          |      | Q (l/min)             | 17  | 33  | 50  | 67  | 83  | 100 | 117 | 133 | 142 |
| LVRm5-2  | 0.37 |                       | 13  | 12  | 12  | 10  | 9   | 7   | 6   |     |     |
| LVR5-2   | 0.37 |                       | 13  | 12  | 12  | 10  | 9   | 7   | 6   |     |     |
| LVRm5-3  | 0.55 |                       | 19  | 19  | 18  | 16  | 15  | 12  | 10  |     |     |
| LVR5-3   | 0.55 |                       | 19  | 19  | 18  | 16  | 15  | 12  | 10  |     |     |
| LVRm5-4  | 0.55 |                       | 26  | 25  | 24  | 22  | 19  | 16  | 14  |     |     |
| LVR5-4   | 0.55 |                       | 26  | 25  | 24  | 22  | 19  | 16  | 14  |     |     |
| LVRm5-5  | 0.75 |                       | 33  | 32  | 30  | 28  | 24  | 22  | 18  |     |     |
| LVR5-5   | 0.75 |                       | 33  | 32  | 30  | 28  | 24  | 22  | 18  |     |     |
| LVRm5-6  | 1.1  |                       | 40  | 38  | 37  | 34  | 28  | 27  | 23  |     |     |
| LVR5-6   | 1.1  |                       | 40  | 38  | 37  | 34  | 28  | 27  | 23  |     |     |
| LVRm5-7  | 1.1  |                       | 46  | 45  | 42  | 40  | 32  | 32  | 27  |     |     |
| LVR5-7   | 1.1  |                       | 46  | 45  | 42  | 40  | 32  | 32  | 27  |     |     |
| LVRm5-8  | 1.1  |                       | 53  | 51  | 48  | 45  | 40  | 36  | 31  |     |     |
| LVR5-8   | 1.1  |                       | 53  | 51  | 48  | 45  | 40  | 36  | 31  |     |     |
| LVRm5-9  | 1.5  |                       | 60  | 59  | 56  | 53  | 47  | 44  | 37  |     |     |
| LVR5-9   | 1.5  |                       | 60  | 59  | 56  | 53  | 47  | 44  | 37  |     |     |
| LVRm5-10 | 1.5  |                       | 67  | 65  | 62  | 59  | 53  | 48  | 41  |     |     |
| LVR5-10  | 1.5  |                       | 67  | 65  | 62  | 59  | 53  | 48  | 41  |     |     |
| LVRm5-11 | 2.2  |                       | 74  | 73  | 70  | 66  | 59  | 54  | 47  |     |     |
| LVR5-11  | 2.2  |                       | 74  | 73  | 70  | 66  | 59  | 54  | 47  |     |     |
| LVRm5-12 | 2.2  |                       | 81  | 79  | 76  | 72  | 63  | 59  | 51  |     |     |
| LVR5-12  | 2.2  |                       | 81  | 79  | 76  | 72  | 63  | 59  | 51  |     |     |
| LVRm5-13 | 2.2  |                       | 88  | 85  | 82  | 78  | 68  | 64  | 55  |     |     |
| LVR5-13  | 2.2  |                       | 88  | 85  | 82  | 78  | 68  | 64  | 55  |     |     |
| LVRm5-14 | 2.2  |                       | 95  | 92  | 89  | 83  | 74  | 69  | 60  |     |     |
| LVR5-14  | 2.2  |                       | 95  | 92  | 89  | 83  | 74  | 69  | 60  |     |     |
| LVRm5-15 | 2.2  |                       | 101 | 99  | 95  | 89  | 79  | 74  | 63  |     |     |
| LVR5-15  | 2.2  |                       | 101 | 99  | 95  | 89  | 79  | 74  | 63  |     |     |
| LVRm5-16 | 2.2  |                       | 108 | 105 | 101 | 95  | 85  | 78  | 68  |     |     |
| LVR5-16  | 2.2  |                       | 108 | 105 | 101 | 95  | 85  | 78  | 68  |     |     |
| LVRm5-18 | 3    |                       | 122 | 119 | 115 | 109 | 98  | 90  | 78  |     |     |
| LVR5-18  | 3    |                       | 122 | 119 | 115 | 109 | 98  | 90  | 78  |     |     |
| LVRm5-20 | 3    |                       | 135 | 132 | 127 | 120 | 108 | 100 | 87  |     |     |
| LVR5-20  | 3    |                       | 135 | 132 | 127 | 120 | 108 | 100 | 87  |     |     |
| LVR5-22  | 4    |                       | 150 | 147 | 142 | 134 | 120 | 112 | 97  |     |     |
| LVR5-24  | 4    |                       | 163 | 160 | 154 | 146 | 132 | 122 | 106 |     |     |
| LVR5-26  | 4    |                       | 176 | 173 | 166 | 157 | 145 | 132 | 115 |     |     |
| LVR5-29  | 4    |                       | 198 | 194 | 188 | 178 | 155 | 149 | 131 |     |     |
| LVR5-36  | 5.5  |                       | 244 | 237 | 231 | 218 | 205 | 185 | 163 | 136 | 120 |

## Hydraulic performance

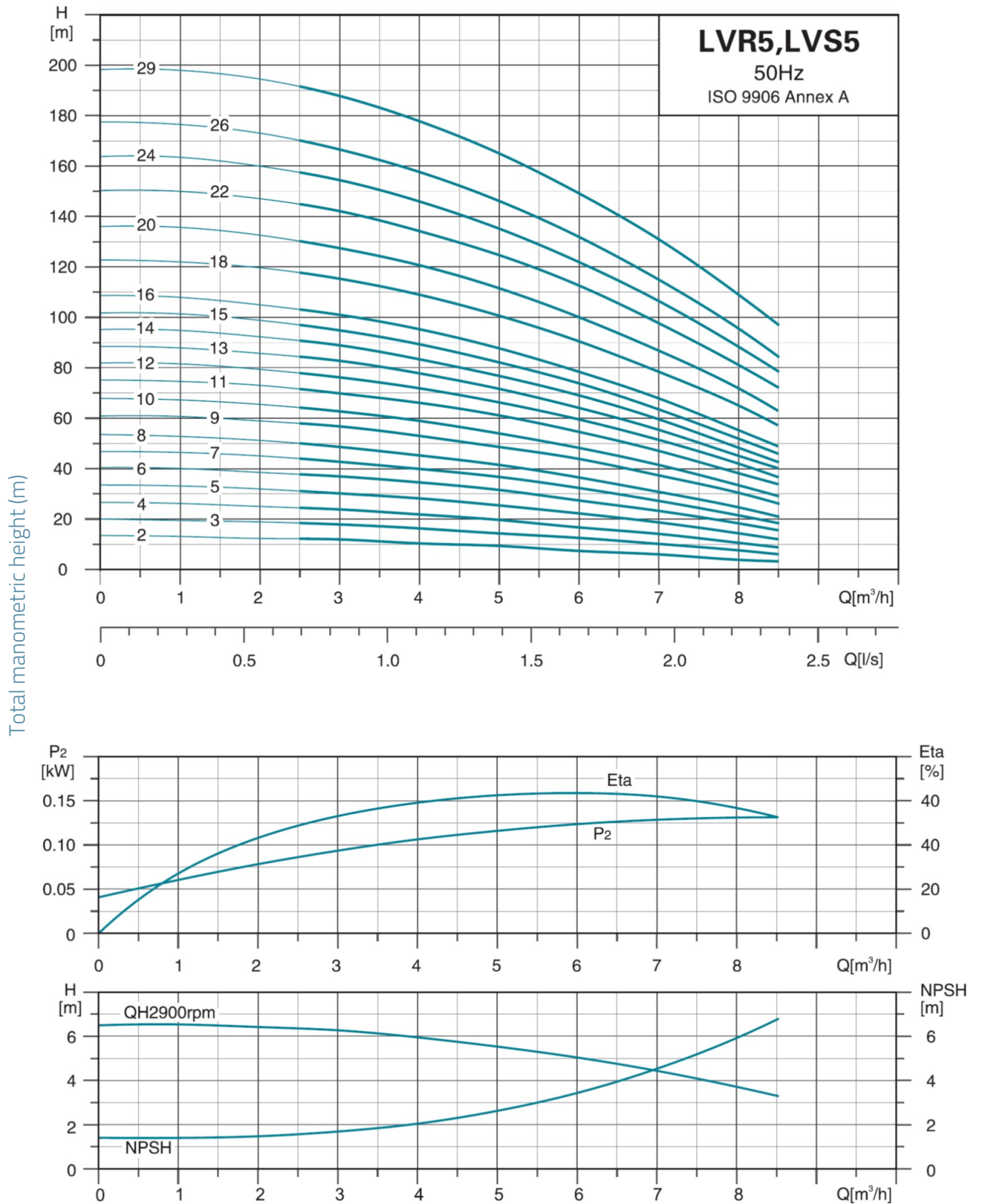

## Dimensions

| MODEL    | B1/bride-ovale | B1+B2/bride-ovale | B1/bride-DIN | B1+B2/bride-DIN | D1  | D2  | poids |
|----------|----------------|-------------------|--------------|-----------------|-----|-----|-------|
| LVRm5-2  | 256            | 470               | 282          | 496             | 130 | 105 | 20.9  |
| LVR5-2   | 256            | 470               | 282          | 496             | 130 | 105 | 20.9  |
| LVRm5-3  | 283            | 497               | 309          | 523             | 130 | 105 | 21.8  |
| LVR5-3   | 283            | 497               | 309          | 523             | 130 | 105 | 21.8  |
| LVRm5-4  | 310            | 524               | 336          | 550             | 130 | 105 | 22.7  |
| LVR5-4   | 310            | 524               | 336          | 550             | 130 | 105 | 22.7  |
| LVRm5-5  | 341            | 609               | 367          | 635             | 150 | 125 | 25.5  |
| LVR5-5   | 341            | 609               | 367          | 635             | 150 | 125 | 25.5  |
| LVRm5-6  | 368            | 636               | 394          | 662             | 150 | 125 | 27.6  |
| LVR5-6   | 368            | 636               | 394          | 662             | 150 | 125 | 27.6  |
| LVRm5-7  | 395            | 663               | 421          | 689             | 150 | 125 | 28.5  |
| LVR5-7   | 395            | 663               | 421          | 689             | 150 | 125 | 28.5  |
| LVRm5-8  | 422            | 690               | 448          | 716             | 150 | 125 | 29.1  |
| LVR5-8   | 422            | 690               | 448          | 716             | 150 | 125 | 29.1  |
| LVRm5-9  | 465            | 783               | 491          | 809             | 164 | 127 | 37.3  |
| LVR5-9   | 465            | 783               | 491          | 809             | 164 | 127 | 37.3  |
| LVRm5-10 | 492            | 810               | 518          | 836             | 164 | 127 | 37.9  |
| LVR5-10  | 492            | 810               | 518          | 836             | 164 | 127 | 37.9  |
| LVRm5-11 | 519            | 837               | 545          | 863             | 164 | 127 | 39.4  |
| LVR5-11  | 519            | 837               | 545          | 863             | 164 | 127 | 39.4  |
| LVRm5-12 | 546            | 864               | 572          | 890             | 164 | 127 | 39.9  |
| LVR5-12  | 546            | 864               | 572          | 890             | 164 | 127 | 39.9  |
| LVRm5-13 | 573            | 891               | 599          | 917             | 164 | 127 | 40.5  |
| LVR5-13  | 573            | 891               | 599          | 917             | 164 | 127 | 40.5  |
| LVRm5-14 | 600            | 918               | 626          | 944             | 164 | 127 | 40.9  |
| LVR5-14  | 600            | 918               | 626          | 944             | 164 | 127 | 40.9  |
| LVRm5-15 | 627            | 945               | 653          | 971             | 164 | 127 | 41.5  |
| LVR5-15  | 627            | 945               | 653          | 971             | 164 | 127 | 41.5  |
| LVRm5-16 | 654            | 972               | 680          | 998             | 164 | 127 | 42.4  |
| LVR5-16  | 654            | 972               | 680          | 998             | 164 | 127 | 42.4  |
| LVRm5-18 | 712            | 1052              | 738          | 1078            | 186 | 120 | 49.9  |
| LVR5-18  | 712            | 1052              | 738          | 1078            | 186 | 120 | 49.9  |
| LVRm5-20 | 766            | 1106              | 792          | 1132            | 186 | 120 | 51.3  |
| LVR5-20  | 766            | 1106              | 792          | 1132            | 186 | 120 | 51.3  |
| LVR5-22  | 820            | 1160              | 846          | 1186            | 186 | 120 | 54.2  |
| LVR5-24  | 874            | 1214              | 900          | 1240            | 186 | 120 | 55.5  |
| LVR5-26  | 928            | 1268              | 954          | 1294            | 186 | 120 | 58.2  |
| LVR5-29  | 1009           | 1349              | 1035         | 1375            | 186 | 120 | 59.9  |
| LVR5-36  |                |                   | 1249         | 1648            | 210 | 142 |       |

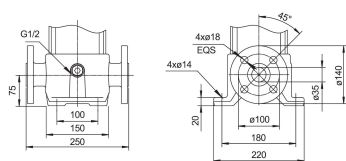
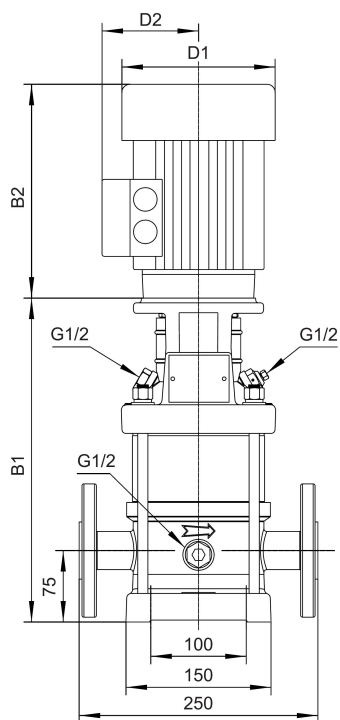

Brides LVR5

## Options

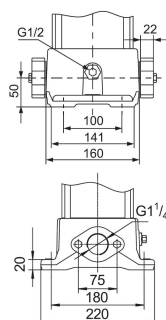

Oval flange (A)

| No. | Type                        | Materials                |
|-----|-----------------------------|--------------------------|
| 1   | Lower water box             | cast iron HT200          |
| 2   | Drain plug                  | AISI 304 stainless steel |
| 3   | Diffuser                    | AISI 304 stainless steel |
| 4   | Diffuser with bearing       | AISI 304 stainless steel |
| 5   | Intermediate diffuser       | AISI 304 stainless steel |
| 6   | Impeller                    | AISI 304 stainless steel |
| 7   | Final scroll                | AISI 304 stainless steel |
| 8   | Lantern                     | cast iron HT200          |
| 9   | Filling plug                | AISI 304 stainless steel |
| 10  | Coupling                    |                          |
| 11  | Engine                      |                          |
| 12  | Coupling protection housing | AISI 304 stainless steel |
| 13  | Cartridge mechanical seal   |                          |
| 14  | Drain plug                  | AISI 304 stainless steel |
| 15  | Pump shaft                  | AISI 304 stainless steel |
| 16  | Jacket                      | AISI 304 stainless steel |
| 17  | Flange                      | cast iron HT200          |

