

Scope of Performance LVS (R)

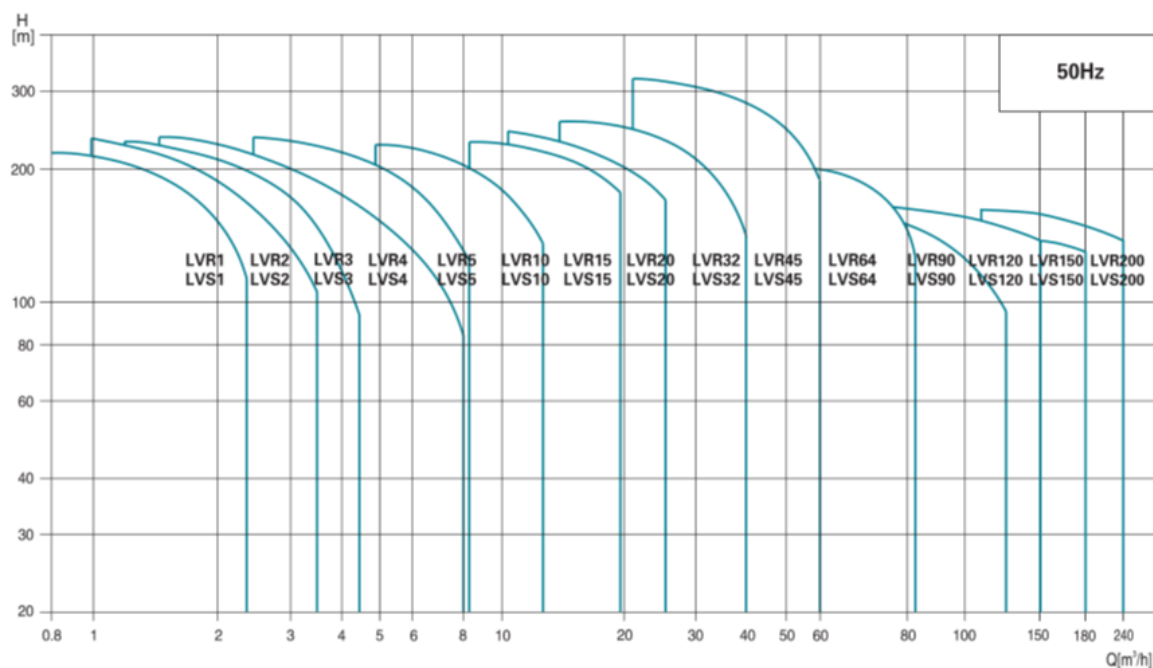

Product Range

MODEL	LVR(S)1	LVR(S)2	LVR(S)3	LVR(S)4	LVR(S)5	LVR(S)10	LVR(S)15	LVR(S)20	LVR(S)32	LVR(S)45	LVR(S)64	LVR(S)90	LVR(S)120	LVR(S)150	LVR(S)200
DESCRIPTION															
Rated flow [m³/h]	1	2	3	4	5	10	15	20	32	45	64	90	120	150	200
Flow range [m³/h]	0.7-2.4	1.0-3.5	1.2-4.5	1.5-8	2.5-8.5	5-13	8-23	10.5-29	15-40	22-58	30-85	45-120	60-150	80-180	100-240
Max. pressure [bar]	22	23	24	21	24	22	23	25	28	33	22	20	16	16	16
Motor power [kW]	0.37-2.2	0.37-3	0.37-3	0.37-4	0.37-4	1.1-7.5	1.1-15	1.1-18.5	1.5-30	3-45	4-45	5.5-45	11-75	11-75	18.5-110
Temperature Range [°C]	-20°C--+120°C (Note: Both the Max. permissible pressure and liquid temperature range refer to the pump capacity.)														
Max. pump efficiency [%]	45	46	55	59	60	65	70	72	78	79	80	81	74	73	79
Pipe connection-LVR															
Oval flange	G1	G1	G1	G1 1/4	G1 1/4	-	-	-	-	-	-	-	-	-	-
DIN flange	DN25	DN25	DN25	DN32	DN32	DN40	DN50	DN50	DN65	DN80	DN100	DN100	DN125	DN125	DN150
Pipe connection-LVS															
Oval flange	-	-	-	-	-	-	-	-	-	-	-	-	-	-	-
DIN flange	DN32	DN32	DN32	DN32	DN32	DN40	DN50	DN50	DN65	DN80	DN100	DN100	DN125	DN125	DN150
Clamp connector	φ42	φ42	φ42	φ42	φ42	-	-	-	-	-	-	-	-	-	-
Threaded connector	R ₂ 1 1/4	R ₂ 1 1/4	R ₂ 1 1/4	R ₂ 1 1/4	R ₂ 1 1/4	-	-	-	-	-	-	-	-	-	-

Ambient Temperature

An ambient temperature of over 40 ° C or an installation at an altitude above 1000 meters above sea level requires an oversized motor. Due to low air density and poor cooling, the output power P₂ decreases, as shown in the table below:

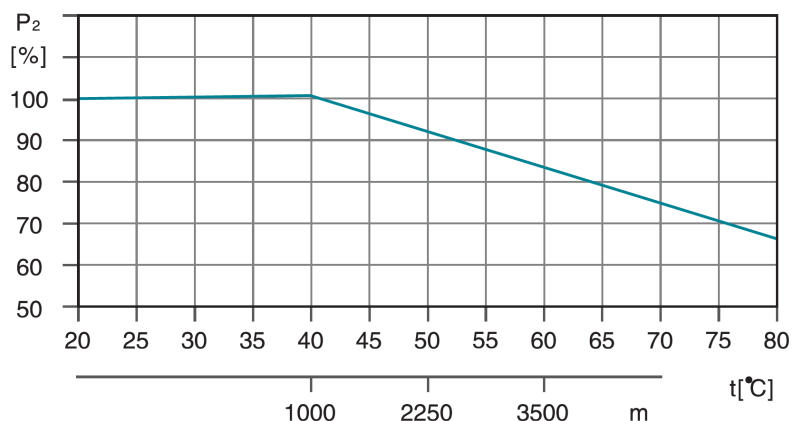

For example, when the pump is installed at an altitude of 3500 meters, P₂ will decrease by 88%. And when the ambient temperature is 70 ° C, P₂ will decrease by 78%.

Maximum Operation pressure (bar)

The table below shows the maximum discharge pressures of the various LVS (R) pumps. The suction pressure of the pump + the set pressure must always be lower than the maximum operating pressure of the pump. If the maximum working pressure is exceeded, it can damage the motor bearings and reduce the service life of the mechanical seal.

Model	LVR Max. Operation pressure [bar]		LVS Max. Operation pressure [bar]
	Oval Flange	DIN Flange	
LVR (S) 1	16	25	25
LVR (S) 2	16	25	25
LVR (S) 3	16	25	25
LVR (S) 4	16	25	25
LVR (S) 5	16	25	25
LVR (S) 10		25	25
LVR (S) 15		25	25
LVR (S) 20		25	25
LVR (S) 32-1-1 - 32-7	16		16
LVR (S) 32-8-2 - 32-14	30		30
LVR (S) 45-1-1 - 45-5	16		16
LVR (S) 45-6-2 - 45-11	30		30
LVR (S) 45-12-2 - 45-13-2	33		33
LVR (S) 64-1-1 - 64-5	16		16
LVR (S) 64-6-2 - 64-8-1	30		30
LVR (S) 90-1-1 - 90-4	16		16
LVR (S) 90-5-2 - 90-6	30		30
LVR (S) 120-1 - 120-7	20		20
LVR (S) 150-1-1 - 150-6	20		20
LVR (S) 200-1-D - 200-4	20		20

NPSH

Minimum Inlet Pressure–Npsh

Calculation of the inlet pressure “H” is recommended in these situations:

- The liquid temperature is high.
- The flow is significantly higher than the rated flow.
- Water is drawn from depths.
- Water is drawn through long pipes.
- Inlet conditions are poor.

To avoid cavitation, make sure that there is a minimum pressure on the suction side of the pump. The maximum suction lift “H” in meters head can be calculated as follows:

$$H = P_b \times 10.2 - NPSH - H_f - H_v - H_s$$

P_b = Barometric pressure in bar. (Barometric pressure can be set to 1 bar). In closed systems, P_b indicates the system pressure in bar.

NPSH = Net Positive Suction Head in meters head. (To be read from the NPSH curve at the highest flow the pump will be delivering.)

H_f = Friction loss in suction pipe in meters head. (At the highest flow the pump will be delivering.)

H_v = Vapor pressure in meters head. (To be read from the vapor pressure scale. “ H_v ” depends on the liquid temperature “ t_m ”)

H_s = Safety margin=minimum 0.5 meters head.

If the “H” calculated is positive, the pump can operate at a suction lift of maximum “H” meters head.

If the “H” calculated is negative, an inlet pressure of minimum “H” meters head is required.



t_m [°C]	H_v [m]
190	126
180	100
170	79
160	62
150	45
140	40
140	35
130	30
130	25
120	20
110	15
100	12
100	10
90	8.0
90	6.0
80	5.0
80	4.0
70	3.0
60	2.0
50	1.5
50	1.0
40	0.8
40	0.6
30	0.4
30	0.3
20	0.2
10	0.1
0	0

Note: To avoid cavitation, never select a pump with a duty point too far to the right on the NPSH curve. Always check the NPSH value of the pump at the highest possible flow.

LVR3 Vertical multicellular pump, water box and pump base in cast iron



LVR

Application

- Transfer of liquids with low viscosity, non-flammable and non-explosive, not containing solid particles or fibers. These liquids must not chemically attack the materials of the pump.
- Water supply for tall buildings, pumping stations, overpressure
- Washing stations, heating water circulation, air conditioning water circulation, water treatment systems
- Distillation systems, municipal swimming pools
- Irrigation: sprinkling, drip
- Industry
- Fire fighting systems

Pompe

- Liquid temperature: from -20°C to $+120^{\circ}\text{C}$
- Nominal flow: $3\text{ m}^3/\text{h}$
- maximum pressure: 24 bars
- pH between 4 and 10

Moteur

- IE3 motor
- Protection class: IP55
- Maximum ambient temperature: $+40^{\circ}$

Identification codes

LVR m 3 -10 -B /F(A, K, G)

- /F(A, K, G) DIN flange (oval, clamp fitting, threaded fitting)
- B inox 316 (by default, inox 304)
- -10 number of turbines
- 3 Nominal flow (m^3/h)
- m Single-phase motor
- LVR vertical multicellular pump in cast iron

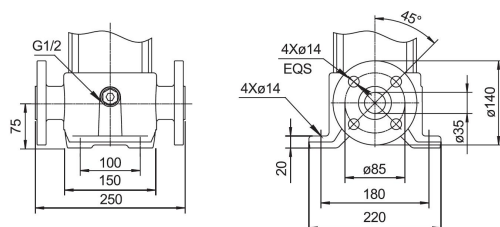

DIN flange (/F)

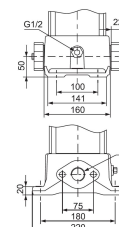

Oval flange (/A)

Options

Technical data

MODEL	kW	Q (m ³ /h)		1.2	1.6	2	2.4	2.8	3.2	3.6	4
		Q (l/min)	20	27	33	40	47	53	60	67	
LVRm3-2	0.37		13	12	12	11	11	10	8	7.5	
LVR3-2	0.37		13	12	12	11	11	10	8	7.5	
LVRm3-3	0.37		19	19	18	17	16	15	14	12	
LVR3-3	0.37		19	19	18	17	16	15	14	12	
LVRm3-4	0.37		25	24	23	22	20	19	17	14	
LVR3-4	0.37		25	24	23	22	20	19	17	14	
LVRm3-5	0.37		31	31	29	27	25	24	20	17	
LVR3-5	0.37		31	31	29	27	25	24	20	17	
LVRm3-6	0.55		37	36	35	33	30	28	24	21	
LVR3-6	0.55		37	36	35	33	30	28	24	21	
LVRm3-7	0.55		43	40	40	37	35	32	28	24	
LVR3-7	0.55		43	40	40	37	35	32	28	24	
LVRm3-8	0.75		51	48	47	44	41	38	33	28	
LVR3-8	0.75		51	48	47	44	41	38	33	28	
LVRm3-9	0.75		56	54	51	48	45	42	36	30	
LVR3-9	0.75		56	54	51	48	45	42	36	30	
LVRm3-10	0.75		62	60	57	54	50	46	40	33	
LVR3-10	0.75		62	60	57	54	50	46	40	33	
LVRm3-11	1.1		69	66	63	60	56	51	44	38	
LVR3-11	1.1		69	66	63	60	56	51	44	38	
LVRm3-12	1.1		75	72	69	65	61	56	48	41	
LVR3-12	1.1		75	72	69	65	61	56	48	41	
LVRm3-13	1.1		80	78	74	70	65	60	51	44	
LVR3-13	1.1		80	78	74	70	65	60	51	44	
LVRm3-15	1.1		92	89	85	80	73	68	58	49	
LVR3-15	1.1		92	89	85	80	73	68	58	49	
LVRm3-17	1.5		107	104	100	94	87	78	70	59	
LVR3-17	1.5		107	104	100	94	87	78	70	59	
LVRm3-19	1.5		119	116	111	104	97	87	77	65	
LVR3-19	1.5		119	116	111	104	97	87	77	65	
LVRm3-21	2.2		133	129	124	117	109	97	88	75	
LVR3-21	2.2		133	129	124	117	109	97	88	75	
LVRm3-23	2.2		146	141	135	128	119	105	95	81	
LVR3-23	2.2		146	141	135	128	119	105	95	81	
LVRm3-25	2.2		158	153	146	138	128	115	102	87	
LVR3-25	2.2		158	153	146	138	128	115	102	87	
LVRm3-27	2.2		170	164	157	148	138	124	110	93	
LVR3-27	2.2		170	164	157	148	138	124	110	93	
LVRm3-29	2.2		182	176	168	159	147	133	118	100	
LVR3-29	2.2		182	176	168	159	147	133	118	100	
LVRm3-31	3		197	191	183	173	161	142	128	110	
LVR3-31	3		197	191	183	173	161	142	128	110	
LVRm3-33	3		210	203	194	194	170	152	137	116	
LVR3-33	3		210	203	194	194	170	152	137	116	
LVRm3-36	3		228	221	211	200	185	165	149	126	
LVR3-36	3		228	221	211	200	185	165	149	126	

Hydraulic performance

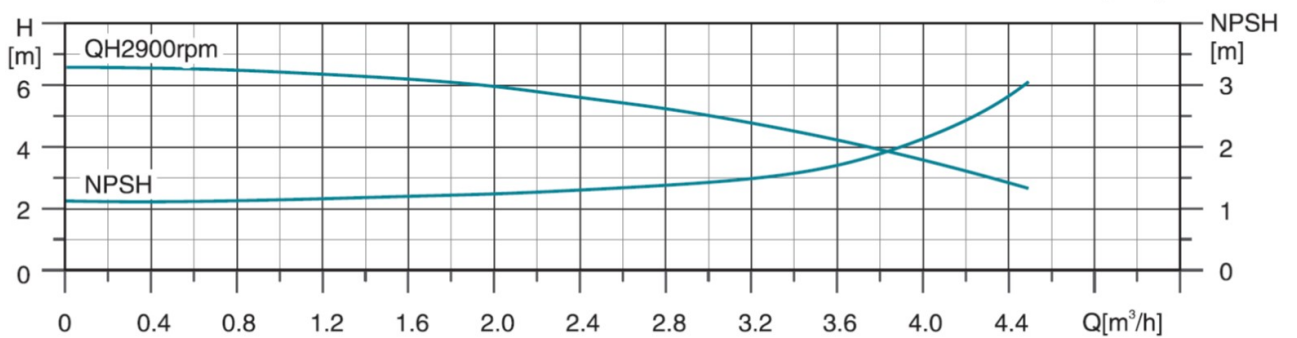
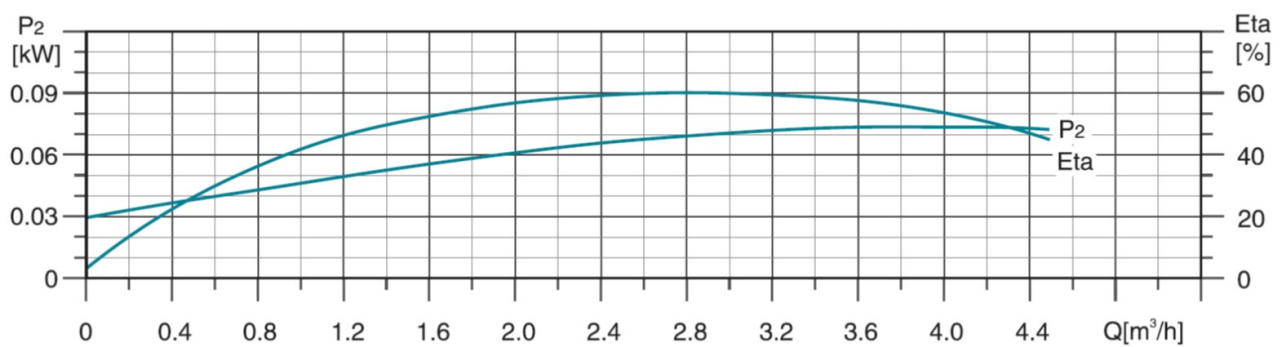
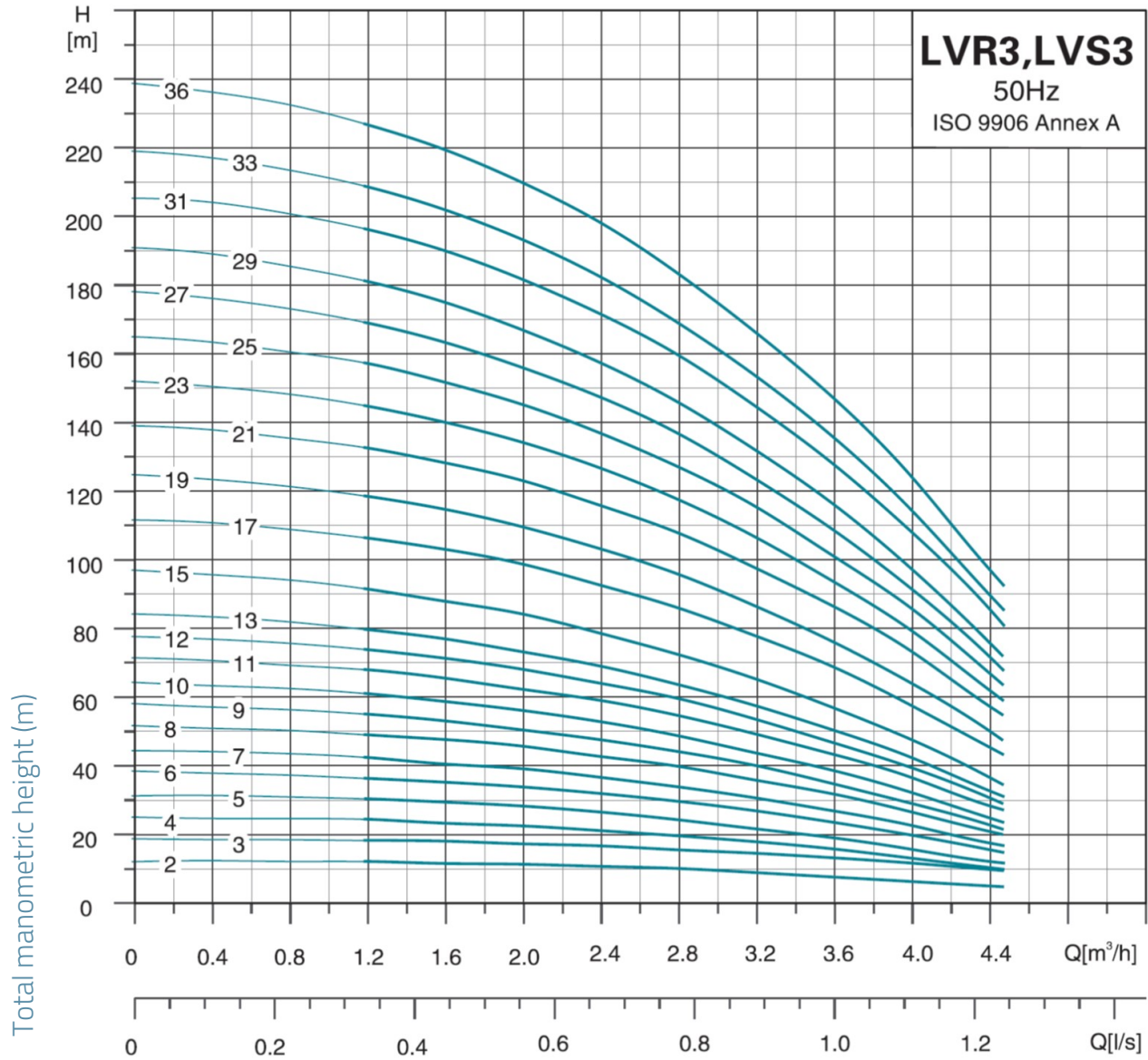

Dimensions

MODEL	B1/bride-ovale	B1+B2/bride-ovale	B1/bride-DIN	B1+B2/bride-DIN	D1	D2	poids
LVRm3-2	256	470	282	496	130	105	21
LVR3-2	256	470	282	496	130	105	21
LVRm3-3	256	470	282	496	130	105	21.4
LVR3-3	256	470	282	496	130	105	21.4
LVRm3-4	274	488	300	514	130	105	21.8
LVR3-4	274	488	300	514	130	105	21.8
LVRm3-5	292	506	318	532	130	105	22.8
LVR3-5	292	506	318	532	130	105	22.8
LVRm3-6	310	524	336	550	130	105	23.3
LVR3-6	310	524	336	550	130	105	23.3
LVRm3-7	328	542	354	568	130	105	23.7
LVR3-7	328	542	354	568	130	105	23.7
LVRm3-8	350	618	376	644	150	124	25.5
LVR3-8	350	618	376	644	150	124	25.5
LVRm3-9	368	636	394	662	150	124	26.6
LVR3-9	368	636	394	662	150	124	26.6
LVRm3-10	386	654	412	680	150	124	27.2
LVR3-10	386	654	412	680	150	124	27.2
LVRm3-11	404	672	430	698	150	124	28.8
LVR3-11	404	672	430	698	150	124	28.8
LVRm3-12	422	690	448	716	150	124	29.7
LVR3-12	422	690	448	716	150	124	29.7
LVRm3-13	440	708	466	734	150	124	30.1
LVR3-13	440	708	466	734	150	124	30.1
LVRm3-15	476	744	502	770	150	124	32.1
LVR3-15	476	744	502	770	150	124	32.1
LVRm3-17	528	846	554	872	164	127	39.2
LVR3-17	528	846	554	872	164	127	39.2
LVRm3-19	564	882	590	908	164	127	40.2
LVR3-19	564	882	590	908	164	127	40.2
LVRm3-21	600	918	626	944	164	127	42.2
LVR3-21	600	918	626	944	164	127	42.2
LVRm3-23	636	954	662	980	164	127	42.4
LVR3-23	636	954	662	980	164	127	42.4
LVRm3-25	672	990	698	1016	164	127	44.4
LVR3-25	672	990	698	1016	164	127	44.4
LVRm3-27	708	1026	734	1052	164	127	44.5
LVR3-27	708	1026	734	1052	164	127	44.5
LVRm3-29	744	1062	770	1088	164	127	45.3
LVR3-29	744	1062	770	1088	164	127	45.3
LVRm3-31	784	1124	810	1150	186	120	52.3
LVR3-31	784	1124	810	1150	186	120	52.3
LVRm3-33	820	1160	846	1186	186	120	53.1
LVR3-33	820	1160	846	1186	186	120	53.1
LVRm3-36	874	1214	900	1240	186	120	54.7
LVR3-36	874	1214	900	1240	186	120	54.7

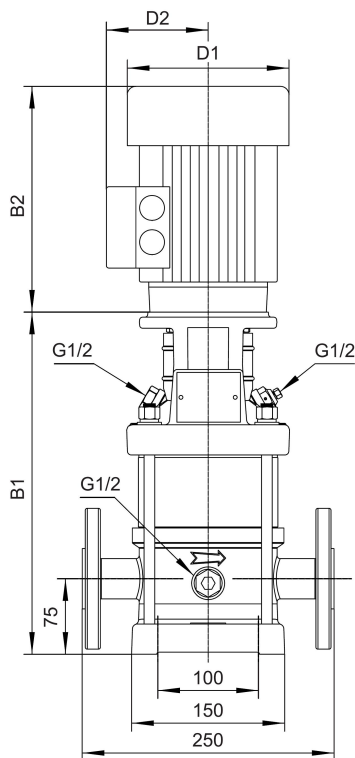

Exploded view

No.	Type	Materials
1	Lower water box	cast iron HT200
2	Drain plug	AISI 304 stainless steel
3	Diffuser	AISI 304 stainless steel
4	Diffuser with bearing	AISI 304 stainless steel
5	Intermediate diffuser	AISI 304 stainless steel
6	Impeller	AISI 304 stainless steel
7	Final scroll	AISI 304 stainless steel
8	Lantern	cast iron HT200
9	Filling plug	AISI 304 stainless steel
10	Coupling	
11	Engine	
12	Coupling protection housing	AISI 304 stainless steel
13	Cartridge mechanical seal	
14	Drain plug	AISI 304 stainless steel
15	Pump shaft	AISI 304 stainless steel
16	Jacket	AISI 304 stainless steel
17	Flange	cast iron HT200

