

### Scope of Performance LVS (R)

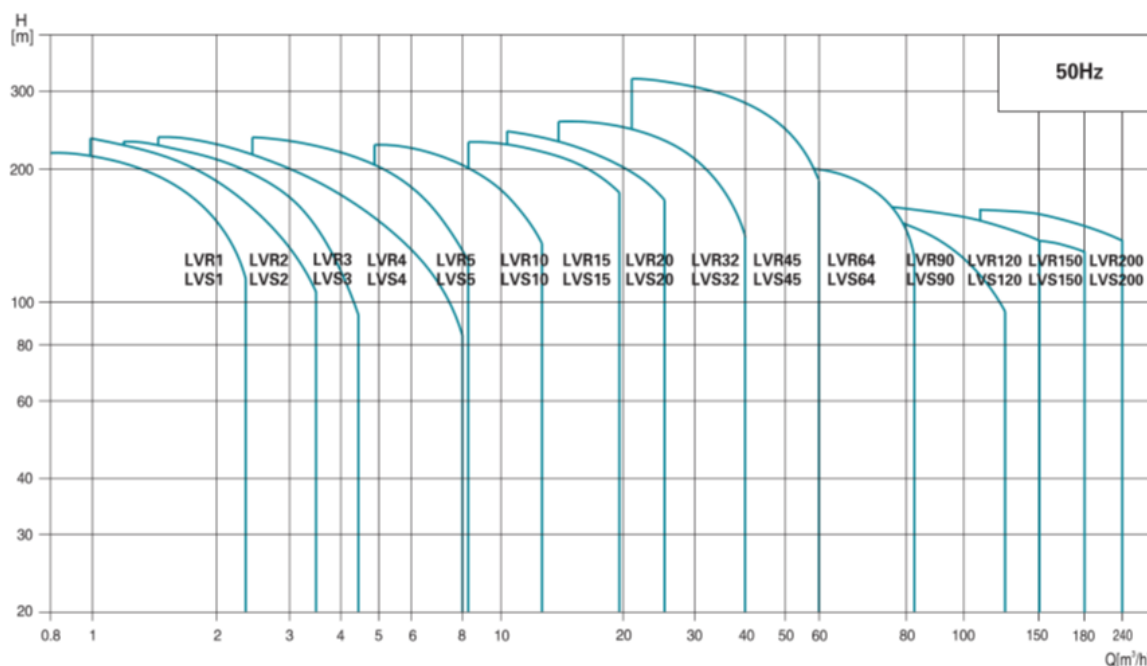

### Product Range

MODEL	LVR(S)1	LVR(S)2	LVR(S)3	LVR(S)4	LVR(S)5	LVR(S)10	LVR(S)15	LVR(S)20	LVR(S)32	LVR(S)45	LVR(S)64	LVR(S)90	LVR(S)120	LVR(S)150	LVR(S)200
<b>DESCRIPTION</b>															
Rated flow [m³/h]	1	2	3	4	5	10	15	20	32	45	64	90	120	150	200
Flow range [m³/h]	0.7-2.4	1.0-3.5	1.2-4.5	1.5-8	2.5-8.5	5-13	8-23	10.5-29	15-40	22-58	30-85	45-120	60-150	80-180	100-240
Max. pressure [bar]	22	23	24	21	24	22	23	25	28	33	22	20	16	16	16
Motor power [kW]	0.37-2.2	0.37-3	0.37-3	0.37-4	0.37-4	1.1-7.5	1.1-15	1.1-18.5	1.5-30	3-45	4-45	5.5-45	11-75	11-75	18.5-110
Temperature Range [°C]	-20°C--+120°C ( Note: Both the Max. permissible pressure and liquid temperature range refer to the pump capacity.)														
Max. pump efficiency [%]	45	46	55	59	60	65	70	72	78	79	80	81	74	73	79
Pipe connection-LVR															
Oval flange	G1	G1	G1	G1 1/4	G1 1/4	-	-	-	-	-	-	-	-	-	-
DIN flange	DN25	DN25	DN25	DN32	DN32	DN40	DN50	DN50	DN65	DN80	DN100	DN100	DN125	DN125	DN150
Pipe connection-LVS															
Oval flange	-	-	-	-	-	-	-	-	-	-	-	-	-	-	-
DIN flange	DN32	DN32	DN32	DN32	DN32	DN40	DN50	DN50	DN65	DN80	DN100	DN100	DN125	DN125	DN150
Clamp connector	φ42	φ42	φ42	φ42	φ42	-	-	-	-	-	-	-	-	-	-
Threaded connector	R <sub>2</sub> 1 1/4	R <sub>2</sub> 1 1/4	R <sub>2</sub> 1 1/4	R <sub>2</sub> 1 1/4	R <sub>2</sub> 1 1/4	-	-	-	-	-	-	-	-	-	-

## Ambient Temperature

An ambient temperature of over 40 ° C or an installation at an altitude above 1000 meters above sea level requires an oversized motor. Due to low air density and poor cooling, the output power P<sub>2</sub> decreases, as shown in the table below:

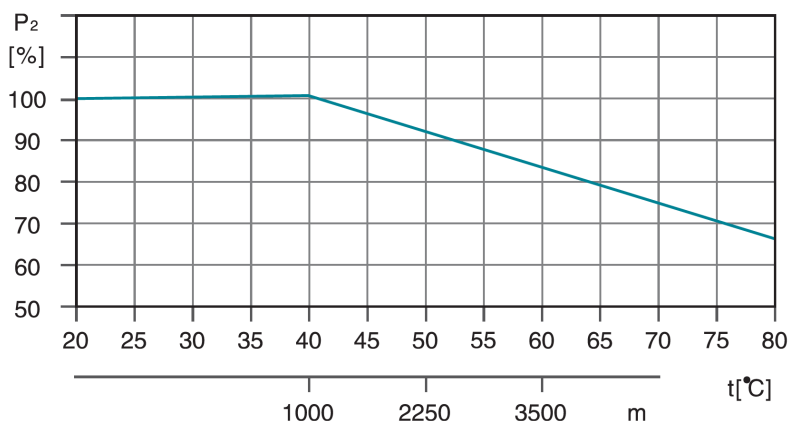

For example, when the pump is installed at an altitude of 3500 meters, P<sub>2</sub> will decrease by 88%. And when the ambient temperature is 70 ° C, P<sub>2</sub> will decrease by 78%.

## Maximum Operation pressure (bar)

The table below shows the maximum discharge pressures of the various LVS (R) pumps. The suction pressure of the pump + the set pressure must always be lower than the maximum operating pressure of the pump. If the maximum working pressure is exceeded, it can damage the motor bearings and reduce the service life of the mechanical seal.

Model	LVR Max. Operation pressure [bar]		LVS Max. Operation pressure [bar]
	Oval Flange	DIN Flange	
LVR (S) 1	16	25	25
LVR (S) 2	16	25	25
LVR (S) 3	16	25	25
LVR (S) 4	16	25	25
LVR (S) 5	16	25	25
LVR (S) 10		25	25
LVR (S) 15		25	25
LVR (S) 20		25	25
LVR (S) 32-1-1 - 32-7	16		16
LVR (S) 32-8-2 - 32-14	30		30
LVR (S) 45-1-1 - 45-5	16		16
LVR (S) 45-6-2 - 45-11	30		30
LVR (S) 45-12-2 - 45-13-2	33		33
LVR (S) 64-1-1 - 64-5	16		16
LVR (S) 64-6-2 - 64-8-1	30		30
LVR (S) 90-1-1 - 90-4	16		16
LVR (S) 90-5-2 - 90-6	30		30
LVR (S) 120-1 - 120-7	20		20
LVR (S) 150-1-1 - 150-6	20		20
LVR (S) 200-1-D - 200-4	20		20

## NPSH

### Minimum Inlet Pressure–Npsh

Calculation of the inlet pressure “H” is recommended in these situations:

- The liquid temperature is high.
- The flow is significantly higher than the rated flow.
- Water is drawn from depths.
- Water is drawn through long pipes.
- Inlet conditions are poor.

To avoid cavitation, make sure that there is a minimum pressure on the suction side of the pump. The maximum suction lift “H” in meters head can be calculated as follows:

$$H = P_b \times 10.2 - NPSH - H_f - H_v - H_s$$

$P_b$  = Barometric pressure in bar. (Barometric pressure can be set to 1 bar). In closed systems,  $P_b$  indicates the system pressure in bar.

NPSH = Net Positive Suction Head in meters head. (To be read from the NPSH curve at the highest flow the pump will be delivering.)

$H_f$  = Friction loss in suction pipe in meters head. (At the highest flow the pump will be delivering.)

$H_v$  = Vapor pressure in meters head. (To be read from the vapor pressure scale. “ $H_v$ ” depends on the liquid temperature “ $t_m$ ”)

$H_s$  = Safety margin=minimum 0.5 meters head.

If the “H” calculated is positive, the pump can operate at a suction lift of maximum “H” meters head.

If the “H” calculated is negative, an inlet pressure of minimum “H” meters head is required.

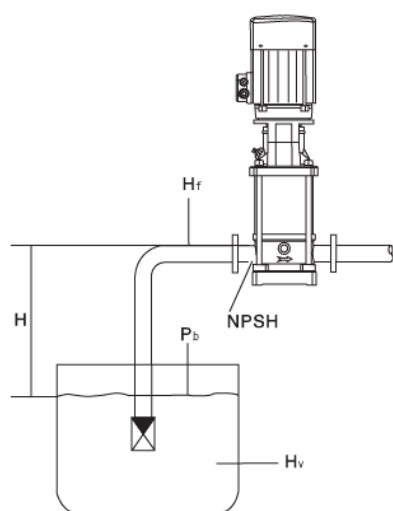

$t_m$ [°C]	$H_v$ [m]
190	126
180	100
170	79
160	62
150	45
140	40
140	35
130	30
130	25
120	20
110	15
100	12
100	10
90	8.0
90	6.0
80	5.0
80	4.0
70	3.0
60	2.0
50	1.5
50	1.0
40	0.8
40	0.6
30	0.4
30	0.3
20	0.2
10	0.1
0	0

**Note:** To avoid cavitation, never select a pump with a duty point too far to the right on the NPSH curve. Always check the NPSH value of the pump at the highest possible flow.

## LVS64 Vertical multicellular stainless steel in line pump



LVS

### Application

- Transfer of liquids with low viscosity, non-flammable and non-explosive, not containing solid particles or fibers. These liquids must not chemically attack the materials of the pump.
- Water supply for tall buildings, pumping stations, overpressure in drinking water
- Washing stations, heating water circulation, air conditioning water circulation, water treatment systems
- Ultrafiltration, reverse osmosis, distillation systems, municipal swimming pools
- Irrigation: sprinkling, drip
- Food industry
- Fire fighting systems

### Pompe

- Liquid temperature: from  $-20^{\circ}\text{C}$  to  $+120^{\circ}\text{C}$
- Nominal flow:  $64\text{ m}^3/\text{h}$
- maximum pressure: 22 bars
- pH between 4 and 10

### Moteur

- IE3 motor
- Protection class: IP55
- Maximum ambient temperature:  $+40^{\circ}$

### Identification codes

<b>LVS</b>	<b>64</b>	<b>-5</b>	<b>-2</b>	<b>-B</b>	<b>/F</b>	
						DIN flange
						inox 316 (by default, inox 304)
						number of small impellers
						number of impellers
						Nominal flow ( $\text{m}^3/\text{h}$ )
						Vertical multistage stainless steel in line pump

### Technical data

MODEL	kW	Q (m <sup>3</sup> /h)	30	40	50	60	70	80
		Q (l/min)	500	667	833	1000	1167	1333
LVS64-1-1/F	4		20	19	17.5	15.5	12	8.5
LVS64-1/F	5.5		27	25.5	23.5	21.5	20	17
LVS64-2-1/F	11		48	45.5	42.5	38	34.5	29
LVS64-2-2/F	7.5		40	38	35.5	31	25.5	19
LVS64-2/F	11		55	52.5	49.5	44.5	41.5	36
LVS64-3-1/F	15		75.5	72	67.5	60	55.5	47
LVS64-3-2/F	15		68	65.5	60	54	48.5	40
LVS64-3/F	18.5		83.5	80	76	66.5	64	56
LVS64-4-1/F	22		104	100	94.5	82.5	78.5	67.5
LVS64-4-2/F	18.5		96	92.5	87	76	70	59
LVS64-4/F	22		112	107	102	89	85.5	74.5
LVS64-5-1/F	30		134	129	122	106	102	88
LVS64-5-2/F	30		126	122	115	100	94	80.5
LVS64-5/F	30		141	136	129	113	109	96
LVS64-6-1/F	37		162	156	148	129	124	108
LVS64-6-2/F	30		154	148	140	122	115	99
LVS64-6/F	37		170	163	155	135	131	116
LVS64-7-1/F	37		190	183	173	151	145	126
LVS64-7-2/F	37		182	176	166	145	138	119
LVS64-7/F	45		202	194	184	163	155	136
LVS64-8-1/F	45		222	214	203	180	170	148
LVS64-8-2/F	45		214	207	196	172	163	140

## Hydraulic performance

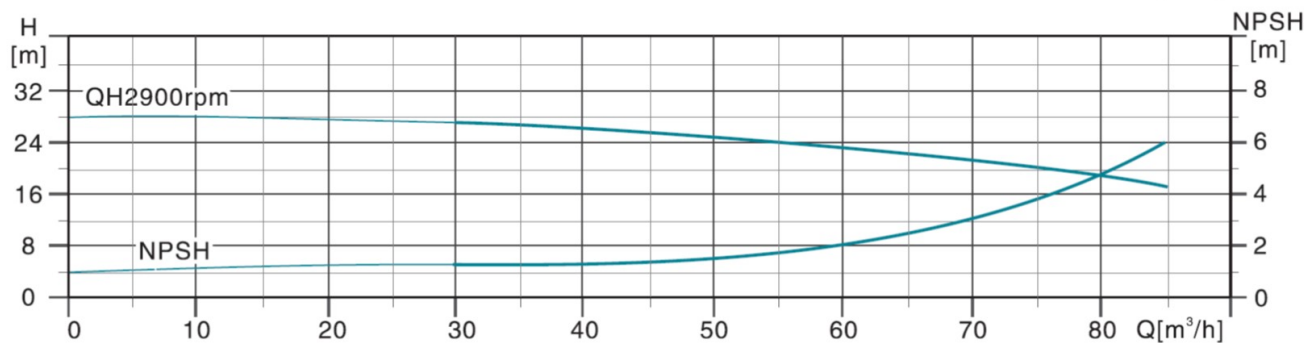
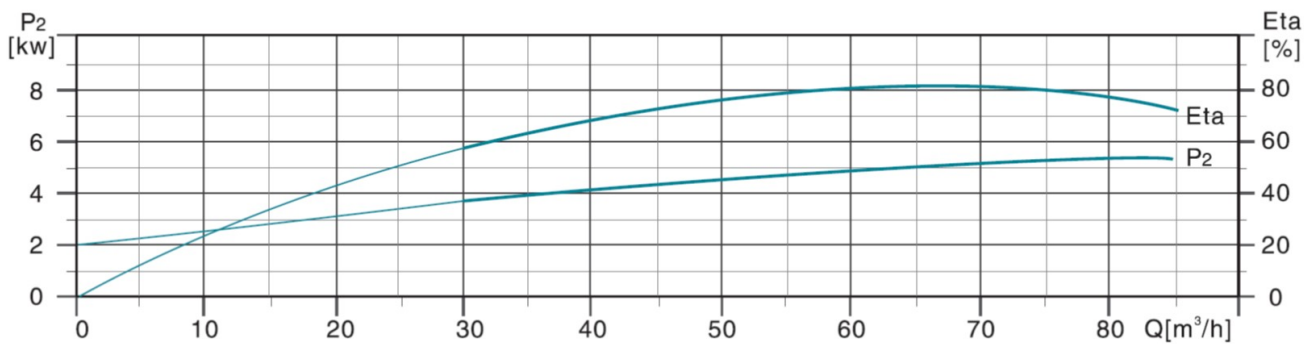
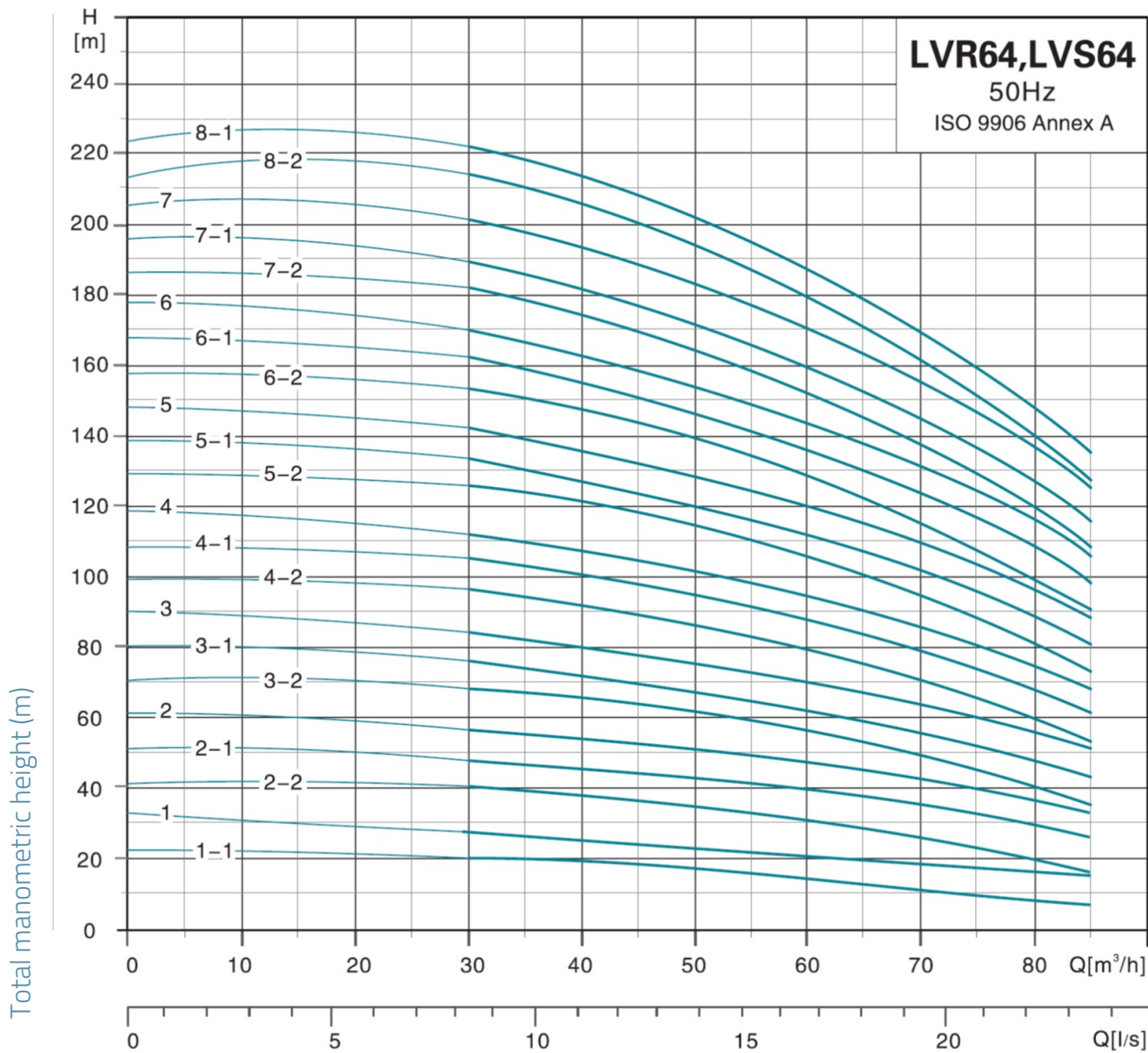

## Dimensions

MODEL	B1	B1+B2	D1	D2	poids
LVS64-1-1/F	563	903	186	124	84.5
LVS64-1/F	563	960	210	142	110.2
LVS64-2-1/F	755	1254	254	175	156
LVS64-2-2/F	645	1042	210	142	117.4
LVS64-2/F	755	1254	254	175	156
LVS64-3-1/F	838	1337	254	175	171.9
LVS64-3-2/F	838	1337	254	175	171.9
LVS64-3/F	838	1398	330	250	221
LVS64-4-1/F	920	1520	380	280	261
LVS64-4-2/F	920	1480	330	250	223.9
LVS64-4/F	920	1520	380	280	261
LVS64-5-1/F	1003	1683	420	305	321.5
LVS64-5-2/F	1003	1683	420	305	321.5
LVS64-5/F	1003	1683	420	305	321.5
LVS64-6-1/F	1085	1765	420	305	341.2
LVS64-6-2/F	1085	1765	420	305	324.5
LVS64-6/F	1085	1765	420	305	341.2
LVS64-7-1/F	1168	1848	420	305	345
LVS64-7-2/F	1168	1848	420	305	344.9
LVS64-7/F	1168	1883	470	335	407.3
LVS64-8-1/F	1250	1965	470	335	410.4
LVS64-8-2/F	1250	1965	470	335	410.7

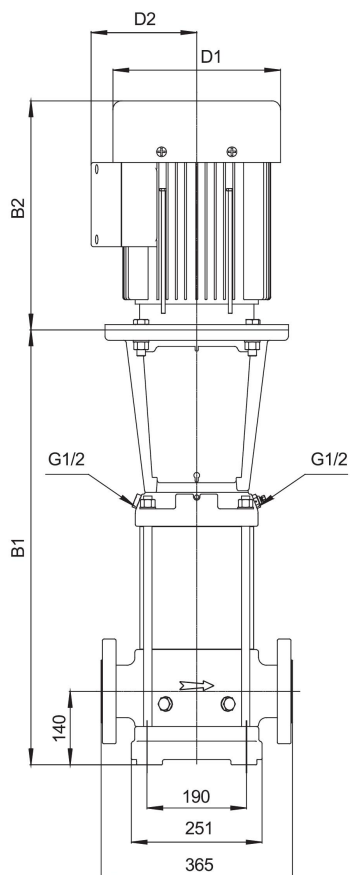

## Exploded view

No.	Type	Materials
1	Base	cast iron HT200
2	Flange	ZG35 cast steel
3	Lower water box	ZG304
4	Diffuser	AISI 304 stainless steel
5	Intermediate diffuser	AISI 304 stainless steel
6	Diffuser with bearing	AISI 304 stainless steel
7	Impeller	AISI 304 stainless steel
8	Shaft sleeve	
9	Diffuser	AISI 304 stainless steel
10	Drain plug	AISI 304 stainless steel
11	Lantern	cast iron HT200
12	Coupling protection housing	
13	Engine	AISI 304 stainless steel
14	Coupling	QT400 cast iron
15	Cartridge mechanical seal	
16	Pump bottom	ZG304
17	Filling plug	AISI 304 stainless steel
18	Clamping plate	AISI 304 stainless steel
19	Jacket	AISI 304 stainless steel
20	Pump shaft	AISI 304 stainless steel

